

## Royalrock X18

Heavy Duty Square

### Glied

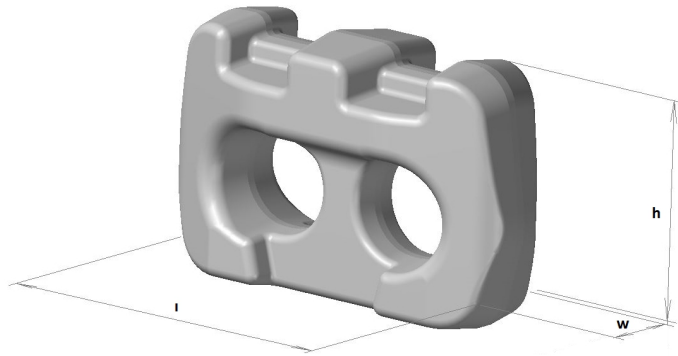

w : 32 mm

h : 59 mm

l : 90 mm

### Ring/Masche

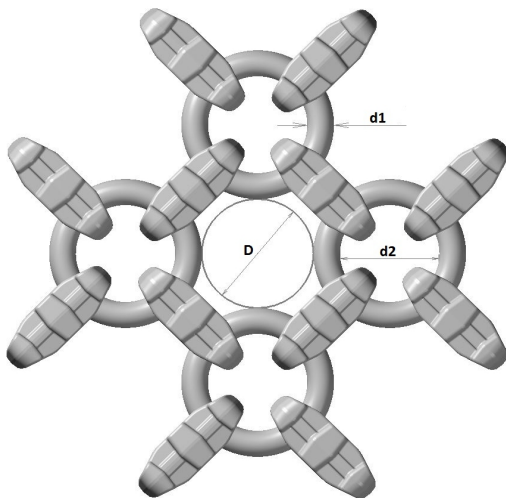

d1 : 18 mm

d2 : 67 mm

D : 75 mm

### Freigängigkeit

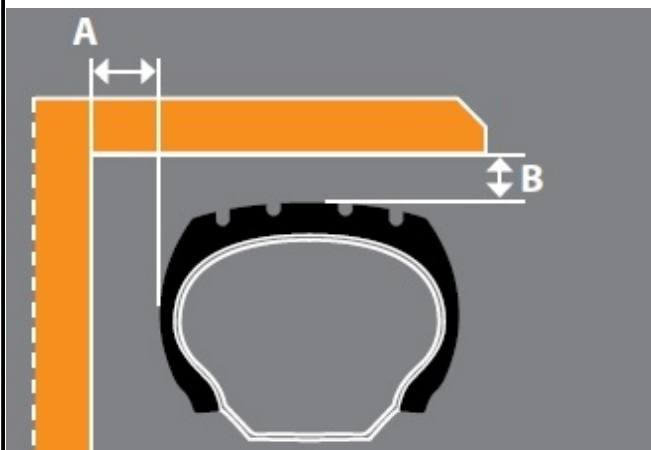

A : 68 mm

B : 98 mm