

## Royalrock X16

Heavy Duty Square

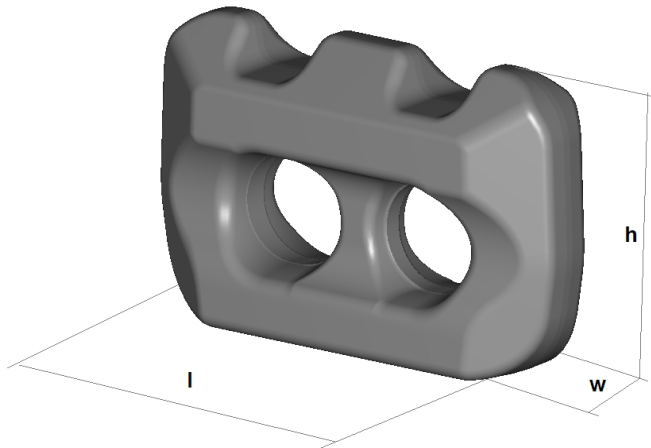

### Glied

w : 23 mm

h : 54 mm

l : 85 mm

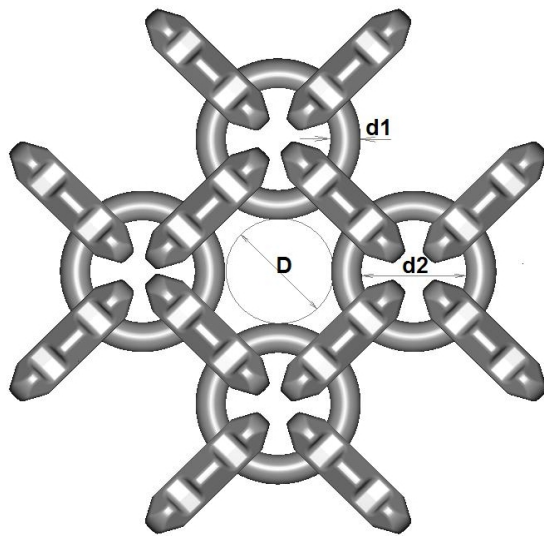

### Ring/Masche

d1 : 16 mm

d2 : 63 mm

D : 62 mm

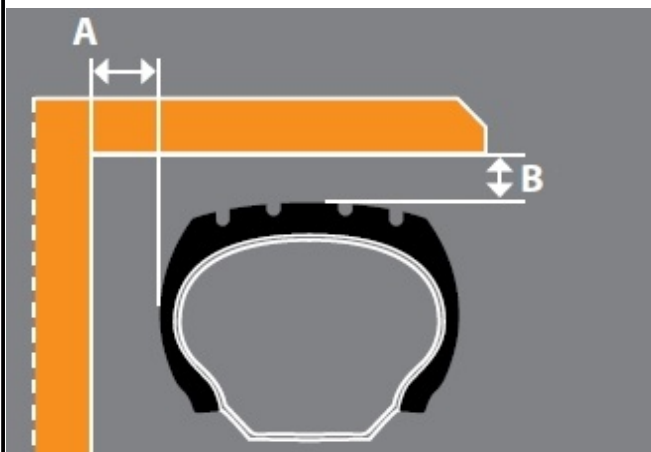

### Freigängigkeit

A : 56 mm

B : 82 mm